

3875081 G E SOLID STATE

01E 18249 DT-39-07

Standard Power MOSFETs

File Number 1562

IRFF110, IRFF111, IRFF112, IRFF113

Power MOS Field-Effect Transistors

N-Channel Enhancement-Mode Power Field-Effect Transistors

3.0A and 3.5A, 60V-100V
 $r_{DS(on)} = 0.6 \Omega$ and 0.8Ω

Features:

- SOA is power-dissipation limited
- Nanosecond switching speeds
- Linear transfer characteristics
- High input impedance
- Majority carrier device

The IRFF110, IRFF111, IRFF112 and IRFF113 are n-channel enhancement-mode silicon-gate power field-effect transistors designed for applications such as switching regulators, switching converters, motor drivers, relay drivers, and drivers for high-power bipolar switching transistors requiring high speed and low gate-drive power. These types can be operated directly from integrated circuits.

The IRFF-types are supplied in the JEDEC TO-205AF (LOW-PROFILE TO-39) metal package.

N-CHANNEL ENHANCEMENT MODE

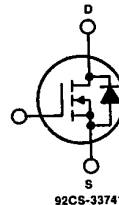

TERMINAL DIAGRAM

TERMINAL DESIGNATION

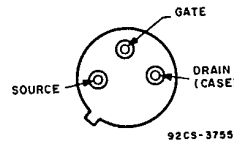

JEDEC TO-205AF

Absolute Maximum Ratings

Parameter	IRFF110	IRFF111	IRFF112	IRFF113	Units
V_{DS} Drain - Source Voltage ①	100	60	100	60	V
V_{DGR} Drain - Gate Voltage ($R_{GS} = 20 K\Omega$) ①	100	60	100	60	V
$I_D @ T_C = 25^\circ C$ Continuous Drain Current	3.5	3.5	3.0	3.0	A
I_{DM} Pulsed Drain Current ②	14	14	12	12	A
V_{GS} Gate - Source Voltage	± 20				V
$P_D @ T_C = 25^\circ C$ Max. Power Dissipation	16		(See Fig. 14)		W
Linear Derating Factor	0.12				(See Fig. 14) W/ $^\circ C$
I_{LM} Inductive Current, Clamped	14	(See Fig. 15 and 16) 14	12	12	A
T_J Operating Junction and Storage Temperature Range	-55 to 150				$^\circ C$
T_{stg} Lead Temperature	300 (0.063 in. (1.6mm) from case for 10s)				$^\circ C$

IRFF110, IRFF111, IRFF112, IRFF113

Electrical Characteristics @ T_C = 25°C (Unless Otherwise Specified)

Parameter	Type	Min.	Typ.	Max.	Units	Test Conditions
BV _{DSS} Drain-Source Breakdown Voltage	IRFF110 IRFF112	100	—	—	V	V _{GS} = 0V
	IRFF111 IRFF113	60	—	—	V	I _D = 250μA
V _{GS(th)} Gate Threshold Voltage	ALL	2.0	—	4.0	V	V _{DS} = V _{GS} , I _D = 250μA
I _{GSS} Gate-Source Leakage Forward	ALL	—	—	100	nA	V _{GS} = 20V
I _{GSS} Gate-Source Leakage Reverse	ALL	—	—	-100	nA	V _{GS} = -20V
I _{DSS} Zero Gate Voltage Drain Current	ALL	—	—	250	μA	V _{DS} = Max. Rating, V _{GS} = 0V
I _{D(on)} On-State Drain Current ②	IRFF110 IRFF111	3.5	—	—	A	V _{DS} = I _{D(on)} × R _{DS(on)} max., V _{GS} = 10V
	IRFF112 IRFF113	3.0	—	—	A	
R _{DS(on)} Static Drain-Source On-State Resistance ②	IRFF110 IRFF111	—	0.5	0.6	Ω	V _{GS} = 10V, I _D = 1.5A
	IRFF112 IRFF113	—	0.6	0.8	Ω	
g _{fs} Forward Transconductance ②	ALL	1.0	1.5	—	S (Ω)	V _{DS} = I _{D(on)} × R _{DS(on)} max., I _D = 1.5A
C _{iss} Input Capacitance	ALL	—	135	200	pF	V _{GS} = 0V, V _{DS} = 25V, f = 1.0 MHz See Fig. 10
C _{oss} Output Capacitance	ALL	—	80	100	pF	
C _{rss} Reverse Transfer Capacitance	ALL	—	20	25	pF	
t _{d(on)} Turn-On Delay Time	ALL	—	10	20	ns	V _{DD} = 0.5 BV _{DSS} , I _D = 1.5A, Z _θ = 500 See Fig. 17 (MOSFET switching times are essentially independent of operating temperature.)
t _r Rise Time	ALL	—	15	25	ns	
t _{d(off)} Turn-Off Delay Time	ALL	—	15	25	ns	
t _f Fall Time	ALL	—	10	20	ns	
Q _g Total Gate Charge (Gate-Source Plus Gate-Drain)	ALL	—	5.0	7.5	nC	V _{GS} = 10V, I _D = 8.0A, V _{DS} = 0.8 Max. Rating. See Fig. 18 for test circuit. (Gate charge is essentially independent of operating temperature.)
Q _{gs} Gate-Source Charge	ALL	—	2.0	—	nC	
Q _{gd} Gate-Drain ("Miller") Charge	ALL	—	3.0	—	nC	
L _D Internal Drain Inductance	ALL	—	5.0	—	nH	Measured from the drain lead, 5 mm (0.2 in.) from header to center of die.
L _S Internal Source Inductance	ALL	—	15	—	nH	Measured from the source lead, 5 mm (0.2 in.) from header to source bonding pad.

Modified MOSFET symbol showing the internal device inductances.

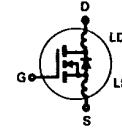

Thermal Resistance

R _{thJC} Junction-to-Case	ALL	—	—	8.33	°C/W	
R _{thJA} Junction-to-Ambient	ALL	—	—	175	°C/W	Free Air Operation

Source-Drain Diode Ratings and Characteristics

I _S Continuous Source Current (Body Diode)	IRFF110 IRFF111	—	—	3.5	A	Modified MOSFET symbol showing the integral reverse P-N junction rectifier.
	IRFF112 IRFF113	—	—	3.0	A	
I _{SM} Pulse Source Current (Body Diode) ③	IRFF110 IRFF111	—	—	14	A	
	IRFF112 IRFF113	—	—	12	A	
V _{SD} Diode Forward Voltage ②	IRFF110 IRFF111	—	—	2.5	V	T _C = 25°C, I _S = 3.5A, V _{GS} = 0V
	IRFF112 IRFF113	—	—	2.0	V	T _C = 25°C, I _S = 3.0A, V _{GS} = 0V
t _{rr} Reverse Recovery Time	ALL	—	200	—	ns	T _J = 150°C, I _F = 3.5A, dI _F /dt = 100A/μs
Q _{RR} Reverse Recovered Charge	ALL	—	1.0	—	μC	T _J = 150°C, I _F = 3.5A, dI _F /dt = 100A/μs
t _{on} Forward Turn-on Time	ALL	Intrinsic turn-on time is negligible. Turn-on speed is substantially controlled by L _S + L _D .				

① T_J = 25°C to 150°C.

② Pulse Test: Pulse width < 300μs, Duty Cycle < 2%.

③ Repetitive Rating: Pulse width limited by max. junction temperature.

See Transient Thermal Impedance Curve (Fig. 5).

Standard Power MOSFETs

IRFF110, IRFF111, IRFF112, IRFF113

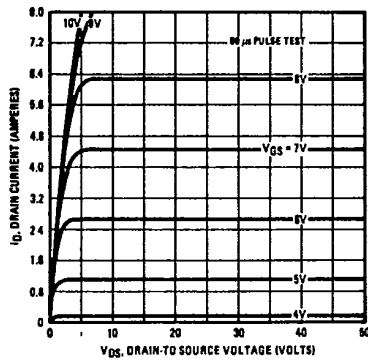

Fig. 1 - Typical Output Characteristics

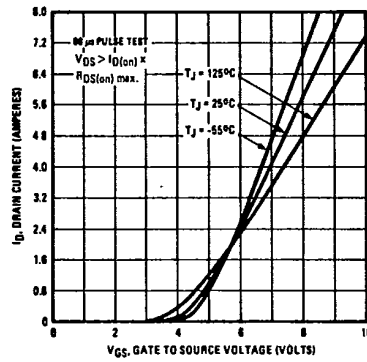

Fig. 2 - Typical Transfer Characteristics

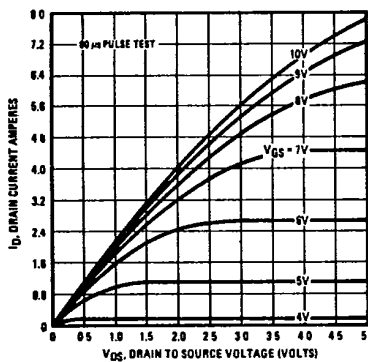

Fig. 3 - Typical Saturation Characteristics

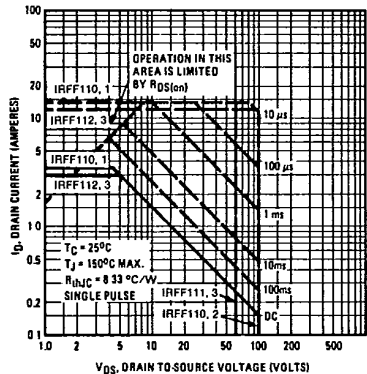

Fig. 4 - Maximum Safe Operating Area

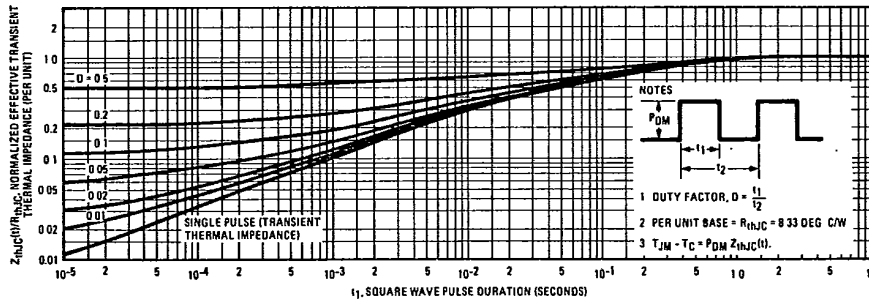

Fig. 5 - Maximum Effective Transient Thermal Impedance, Junction-to-Case Vs. Pulse Duration

IRFF110, IRFF111, IRFF112, IRFF113

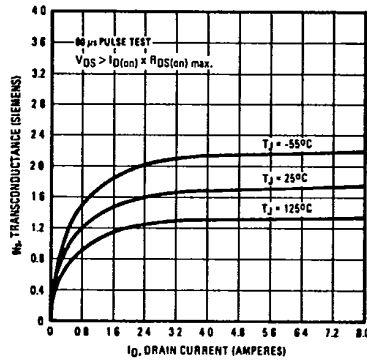

Fig. 6 - Typical Transconductance Vs. Drain Current

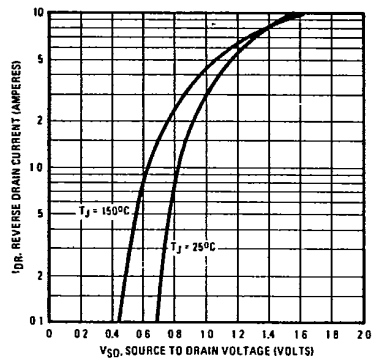

Fig. 7 - Typical Source-Drain Diode Forward Voltage

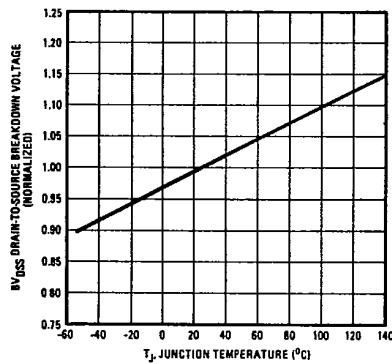

Fig. 8 - Breakdown Voltage Vs. Temperature

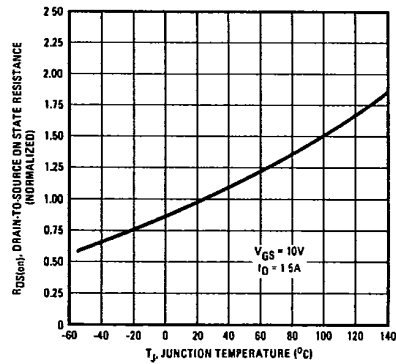

Fig. 9 - Normalized On-Resistance Vs. Temperature

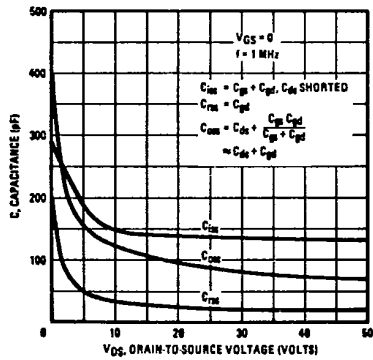

Fig. 10 - Typical Capacitance Vs. Drain-to-Source Voltage

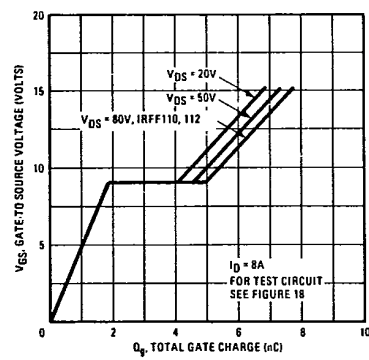

Fig. 11 - Typical Gate Charge Vs. Gate-to-Source Voltage

Standard Power MOSFETs

IRFF110, IRFF111, IRFF112, IRFF113

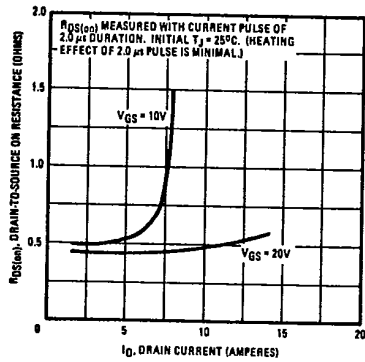

Fig. 12 - Typical On-Resistance Vs. Drain Current

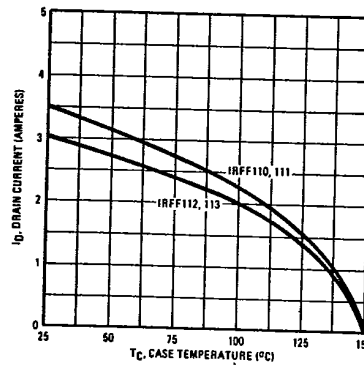

Fig. 13 - Maximum Drain Current Vs. Case Temperature

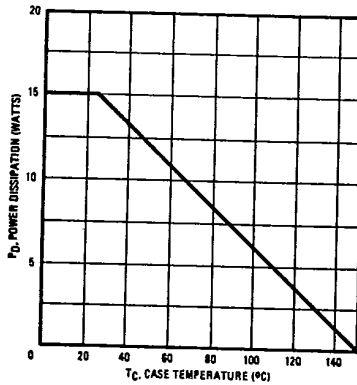

Fig. 14 - Power Vs. Temperature Derating Curve

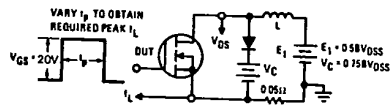

Fig. 15 - Clamped Inductive Test Circuit

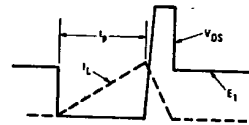

Fig. 16 - Clamped Inductive Waveforms

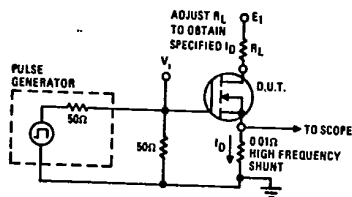

Fig. 17 - Switching Time Test Circuit

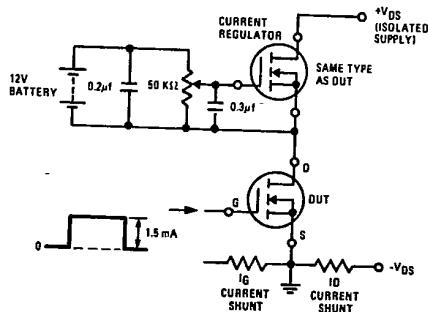

Fig. 18 - Gate Charge Test Circuit